

SOLENOID OPERATED DIRECTIONAL CONTROL

2 way, 2 position, single coil.

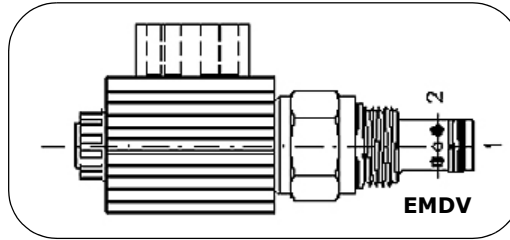
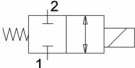
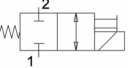
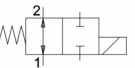
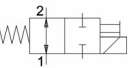
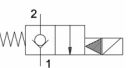
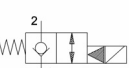
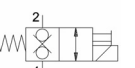
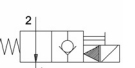
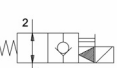
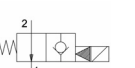
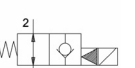

Circuit	Solenoid Operated - Directional Control Valves				
	Part No.	Action	Type	Flow (L/min)	Cavity
	EMDV-08-N-C6-0-XXDG	PULL	SPOOL	19	0820
	EMDV-10-N-C1-0-XXDG EMDV-12-N-C1-0-XXDG	PUSH PUSH	SPOOL	38 68	1020 1220
	EMDV-08-N-O6-0-XXDG	PULL	SPOOL	19	0820
	EMDV-10-N-O1-0-XXDG EMDV-12-N-O1-0-XXDG	PUSH PUSH	SPOOL	30 68	1020 1220
	EMDV-08-N-C7-0-XXDG EMDV-10-N-C2-0-XXDG EMDV-12-N-C2-0-XXDG EMDV-16-N-C2-0-XXDG	PULL PULL PULL PULL	POPPET	38 68 136 190	0820 1020 1220 1620
	EMDV-08-N-C8-0-XXDG EMDV-10-N-C4-0-XXDG EMDV-12-N-C4-0-XXDG EMDV-16-N-C4-0-XXDG	PULL PULL PULL PULL	POPPET	38 68 136 190	0820 1020 1220 1620
	EMDV-08-N-C3-0-XXDG EMDV-10-N-C3-0-XXDG	PUSH PUSH	POPPET	10 23	0820 1020
	EMDV-10-N-O2-0-XXDG EMDV-12-N-O2-0-XXDG EMDV-16-N-O2-0-XXDG	PUSH PUSH PUSH	POPPET	68 136 190	1020 1220 1620
	EMDV-12-N-O4-0-XXDG EMDV-16-N-O4-0-XXDG	PUSH PUSH	POPPET	136 190	1220 1620
	EMDV-08-N-O7-0-XXDG	PUSH	POPPET	38	0820
	EMDV-08-N-O8-0-XXDG	PUSH	POPPET	38	0820

NB: Replace XX in the part number with the voltage ie: 12 or 24 Volt DC
Valves with a 'PULL' action cannot be manually overridden

For line mount bodies to suit the above cartridges refer to section "J". Use the cavity size to select the correct body type then choose the desired port size.

SOLENOID OPERATED DIRECTIONAL CONTROL

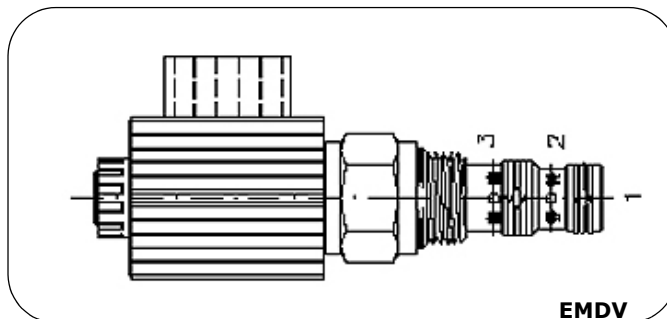

EMDV
3 way, 2 position, spool type, single coil

Circuit	SOLENOID OPERATED - Directional Control				
	Part No.	Action	Centre Configuration	Flow (L/min)	Cavity
	EMDV-10-N-3A-0-XXDG EMDV-10-N-3C-0-XXDG EMDV-12-N-3A-0-XXDG EMDV-12-N-3C-0-XXDG	PUSH	CLOSED OPEN CLOSED OPEN	30 30 68 68	1030 1030 1230 1230
	EMDV-08-N-3J-0-XXDG EMDV-08-N-3K-0-XXDG EMDV-10-N-3B-0-XXDG EMDV-10-N-3D-0-XXDG EMDV-12-N-3B-0-XXDG EMDV-12-N-3D-0-XXDG	PUSH	CLOSED OPEN CLOSED OPEN CLOSED OPEN	19 19 30 30 68 68	0830 0830 1030 1030 1230 1230
	EMDV-08-N-3L-0-XXDG EMDV-08-N-3M-0-XXDG	PUSH	CLOSED OPEN	19 19	0830 0830
	EMDV-10-N-3E-0-XXDG	PUSH	OPEN	30	1030
	EMDV-08-N-3N-0-XXDG EMDV-08-N-3P-0-XXDG	PUSH	CLOSED OPEN	19 19	0830 0830
	EMDV-08-N-3R-0-XXDG	PUSH	OPEN	12	0830

NB: Replace XX in the part number with the voltage ie: 12 or 24 Volt DC

For line mount bodies to suit the above cartridges refer to section "J". Use the cavity size to select the correct body type then choose the desired port size.

SOLENOID OPERATED DIRECTIONAL CONTROL

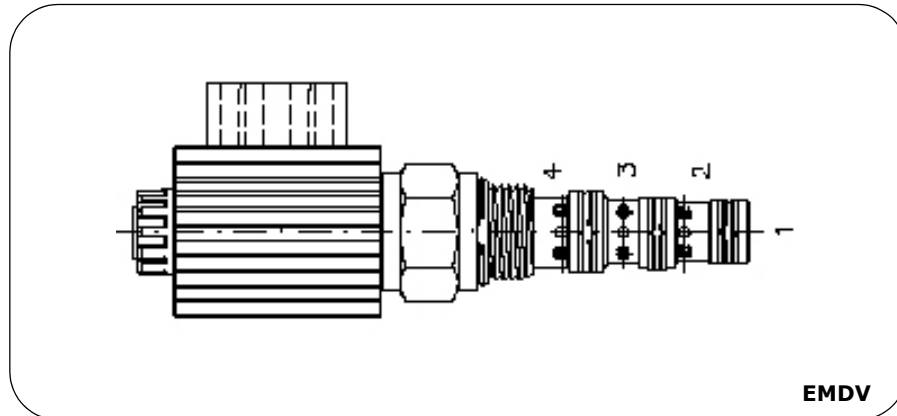

4 way, 2 position, spool type

NB: These items are available with "Soft Shift Option" (EMDV replaced by EMSV)

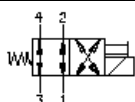
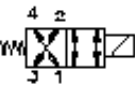
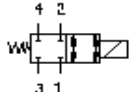
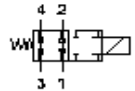
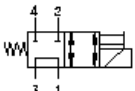
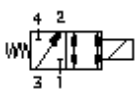
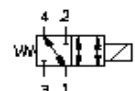
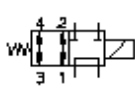
Circuit	Solenoid Operated - Directional Control Valves				
	Part No.	Flow (L/min)	Action	Centre Configuration	Cavity
	EMDV-10-N-4A-0-XXDG EMDV-12-N-4A-0-XXDG EMDV-12-N-4F-0-XXDG	30 60 76	PUSH	CLOSED CLOSED OPEN	1040 1240 1240
	EMDV-08-N-4J-0-XXDG	19	PUSH	CLOSED	0840
	EMDV-08-N-4K-0-XXDG EMDV-10-N-4B-0-XXDG EMDV-12-N-4B-0-XXDG	19 30 60	PUSH	CLOSED CLOSED CLOSED	0840 1040 1240
	EMDV-08-N-4L-0-XXDG EMDV-10-N-4C-0-XXDG EMDV-12-N-4C-0-XXDG	19 30 60	PUSH	CLOSED CLOSED CLOSED	0840 1040 1240
	EMDV-10-N-4D-0-XXDG EMDV-12-N-4D-0-XXDG	30 60	PUSH	CLOSED CLOSED	1040 1240
	EMDV-08-N-4M-0-XXDG	19	PUSH	CLOSED	0840
	EMDV-08-N-4P-0-XXDG	19	PUSH	CLOSED	0840
	EMDV-08-N-4N-0-XXDG	19	PUSH	CLOSED	0840

NB: Replace XX in the part number with the voltage ie: 12 or 24 volt DC

For line mount bodies to suit the above cartridges refer to section "J". Use the cavity size to select the correct body type then choose the desired port size.